

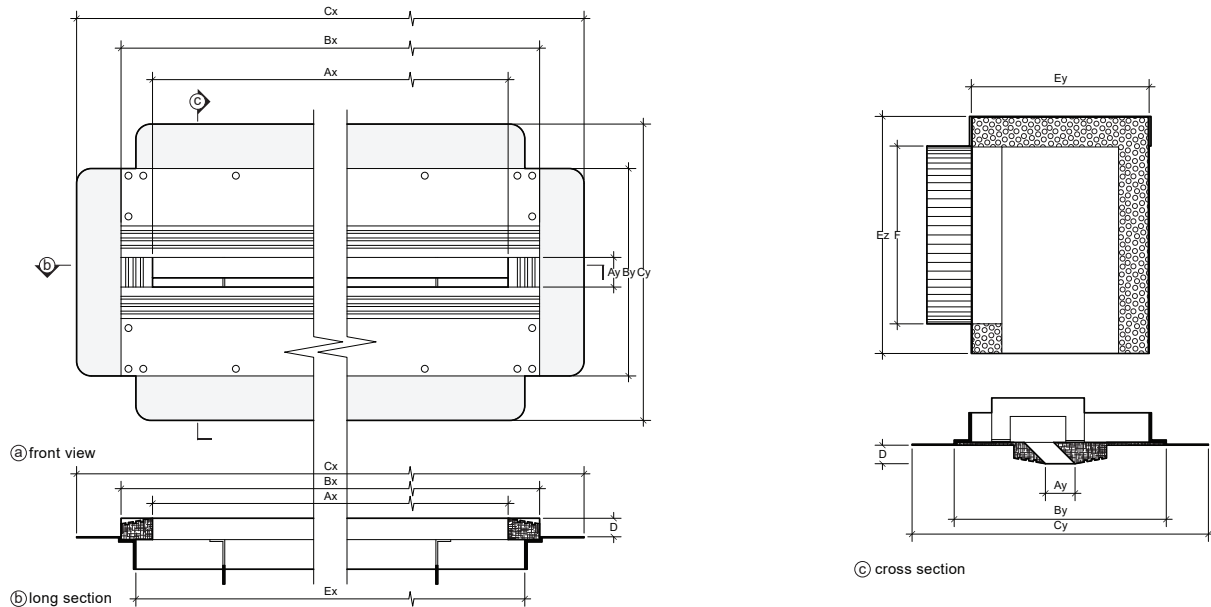

ARCHITECTURAL LINEAR DIFFUSERS MODEL #
L4501200



KEY FEATURES:

- Tape and spackle installation
- ASTM E-84 Class A rated

NOTES:

- Individual sections can be delivered up to 72" long. Longer spans will consist of sections butted together and joined with mending plates
- Total Product Dimensions include end caps.
- Slide plenum box into vertical flanges, screw to secure

PRODUCT DIMENSIONS

(Ax) DIFFUSER LENGTH (SPECIFY)	QTY	(Bx, By) REQ. CEILING FRAME OPENING (Ax + 2 1/2", 8 1/2")	# SLOTS	(Ay) SLOT WIDTH	(Cx, Cy) TOTAL PRODUCT DIMENSIONS (Ax + 5", 11")	ALUMINUM FLANGE WIDTH	(D) GYPSUM BOARD THICKNESS (SPECIFY)
		x 8 1/2"	1	2"	x 11"	1 1/2"	
		x 8 1/2"	1	2"	x 11"	1 1/2"	
		x 8 1/2"	1	2"	x 11"	1 1/2"	
		x 8 1/2"	1	2"	x 11"	1 1/2"	
		x 8 1/2"	1	2"	x 11"	1 1/2"	

OPTIONAL PLENUM BOX SPECIFICATIONS

(Ex) PLENUM LENGTH (Ax + 3/4")	QTY	(Ey) PLENUM WIDTH	(Ez) PLENUM HEIGHT (SPECIFY)	DUCT CONNECTION TYPE	(F) COLLAR SIZE	COLLAR LOC. (TOP/ SIDE/END)	VOLUME DAMPER TYPE	VOLUME DAMPER SIZE
		6 3/4"						
		6 3/4"						
		6 3/4"						
		6 3/4"						
		6 3/4"						

CONTRACTOR	
PROJECT	
ADDRESS	
ENGINEER	
PREPARED BY	

InviAir
67 Guernsey St
Brooklyn, NY 11222
917-909-0343