

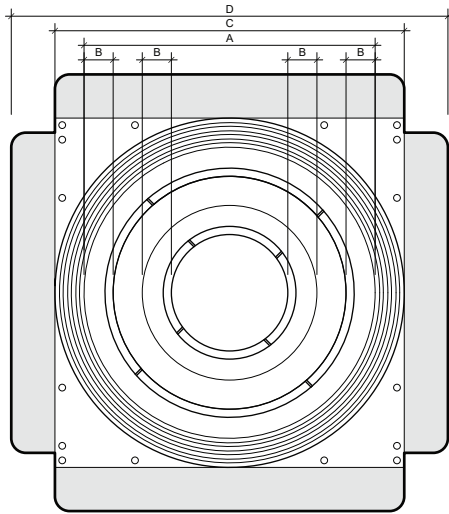

ARCHITECTURAL ROUND DIFFUSERS MODEL #
R2402100

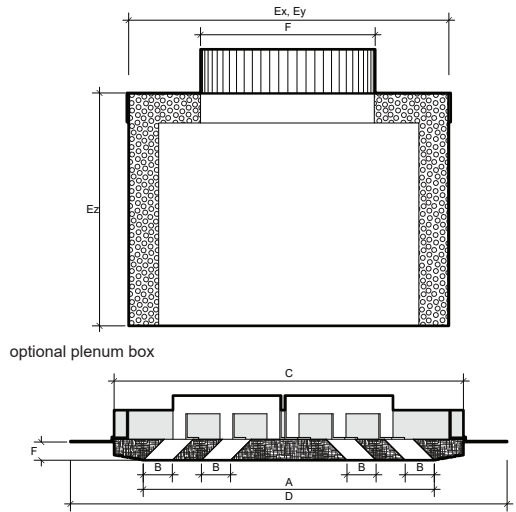

front view



section

KEY FEATURES:

- Tape and spackle installation
- ASTM E-84 Class A rated

NOTES:

- Slide plenum box into vertical flanges and screw to secure
- Product size includes aluminum flanges
- Steel support brackets variable

PRODUCT DIMENSIONS

MODEL #	QTY	# SLOTS	(A) DIFFUSER OPENING	(B) SLOT WIDTH	(C) REQ. CEILING FRAME OPENING	(D) OVERALL PRODUCT DIMENSIONS	ALUMINUM FLANGE WIDTH	(E) GYPSUM BOARD THICKNESS (SPECIFY)
R2402100		2	24"	1"	26.5" x 26.5"	29" x 29"	1 1/2"	

OPTIONAL PLENUM BOX SPECIFICATIONS

(Fx) PLENUM LENGTH	(Fy) PLENUM LENGTH	(Fz) PLENUM HEIGHT (SPECIFY)	QTY	DUCT CONNECTION TYPE	(G) COLLAR SIZE	COLLAR LOCATION (TOP / SIDE)	VOLUME DAMPER TYPE	VOLUME DAMPER SIZE
24 3/4"	24 3/4"							
24 3/4"	24 3/4"							
24 3/4"	24 3/4"							
24 3/4"	24 3/4"							
24 3/4"	24 3/4"							

CONTRACTOR	
PROJECT	
ADDRESS	
ENGINEER	
PREPARED BY	

InviAir
67 Guernsey St
Brooklyn, NY 11222
917-909-0343