

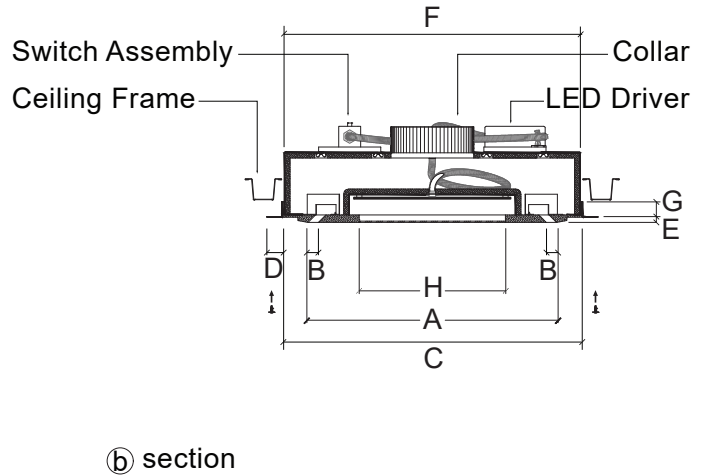

ARCHITECTURAL ROUND DIFFUSERS MODEL
#RL1801100

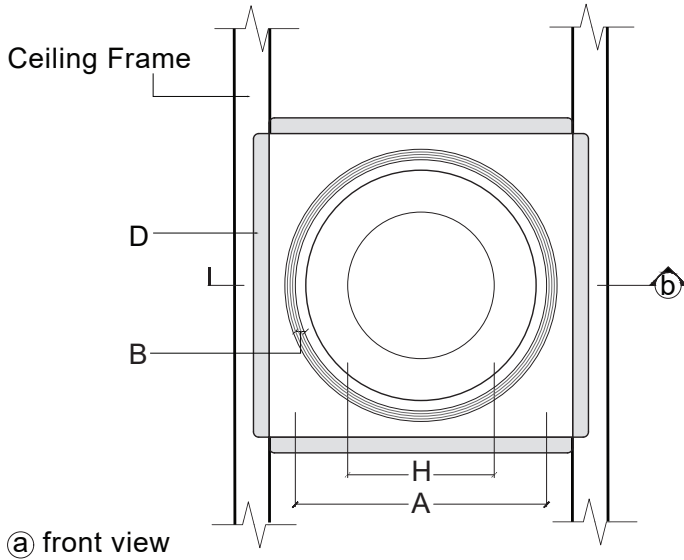

KEY FEATURES:

- Tape and spackle installation
- ASTM E-84 Class A rated

NOTES:

- Custom plenum box provided by Invi, with minimum 6" Height
- Diffuser face removable for access to light assembly
- Light assembly and plenum box lined with foam rubber insulation
- Steel adjustment brackets variable

PRODUCT DIMENSIONS

MODEL #	QTY	# SLOTS	(A) DIFFUSER OPENING	(B) SLOT WIDTH	(C) CEILING FRAME OPENING	(D) STEEL FLANGES	(E) GYPSUM BOARD THICKNESS (SPECIFY)	(G) PLENUM HEIGHT OFFSET	(H) LIGHT SIZE	LIGHT TEMP. WARM /COOL
RL1801100		1	18"	1"	23 1/2"	1 1/2"		1"	13"	
RL1801100		1	18"	1"	23 1/2"	1 1/2"		1"	13"	

PLENUM BOX SPECIFICATIONS

(F) PLENUM LENGTH	(F) PLENUM WIDTH	PLENUM HEIGHT (SPECIFY)	QUANTITY	DUCT CONNECTION TYPE	COLLAR SIZE	COLLAR LOCATION (TOP / SIDE)	VOLUME DAMPER TYPE	VOLUME DAMPER SIZE
22 3/4"	22 3/4"					T S		
22 3/4"	22 3/4"					T S		
22 3/4"	22 3/4"					T S		
22 3/4"	22 3/4"					T S		
22 3/4"	22 3/4"					T S		

CONTRACTOR	
PROJECT	
ADDRESS	
ENGINEER	
PREPARED BY	

InviAir
67 Guernsey St
Brooklyn, NY 11222
917-909-0343